

NOTES:

- 1) Ground, Supply Voltage are solderable terminals
- 2) RF connectors are field replaceable SMA female
- 3) Dimensions are subject to change in the interest of improved product performance

DATE	REVISION	ECO	CHANGES	APPROVED
4/8/05	4/8/05	14037	SWITCHED INPUT AND OUTPUT	BB/SL

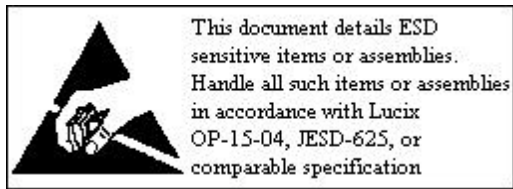
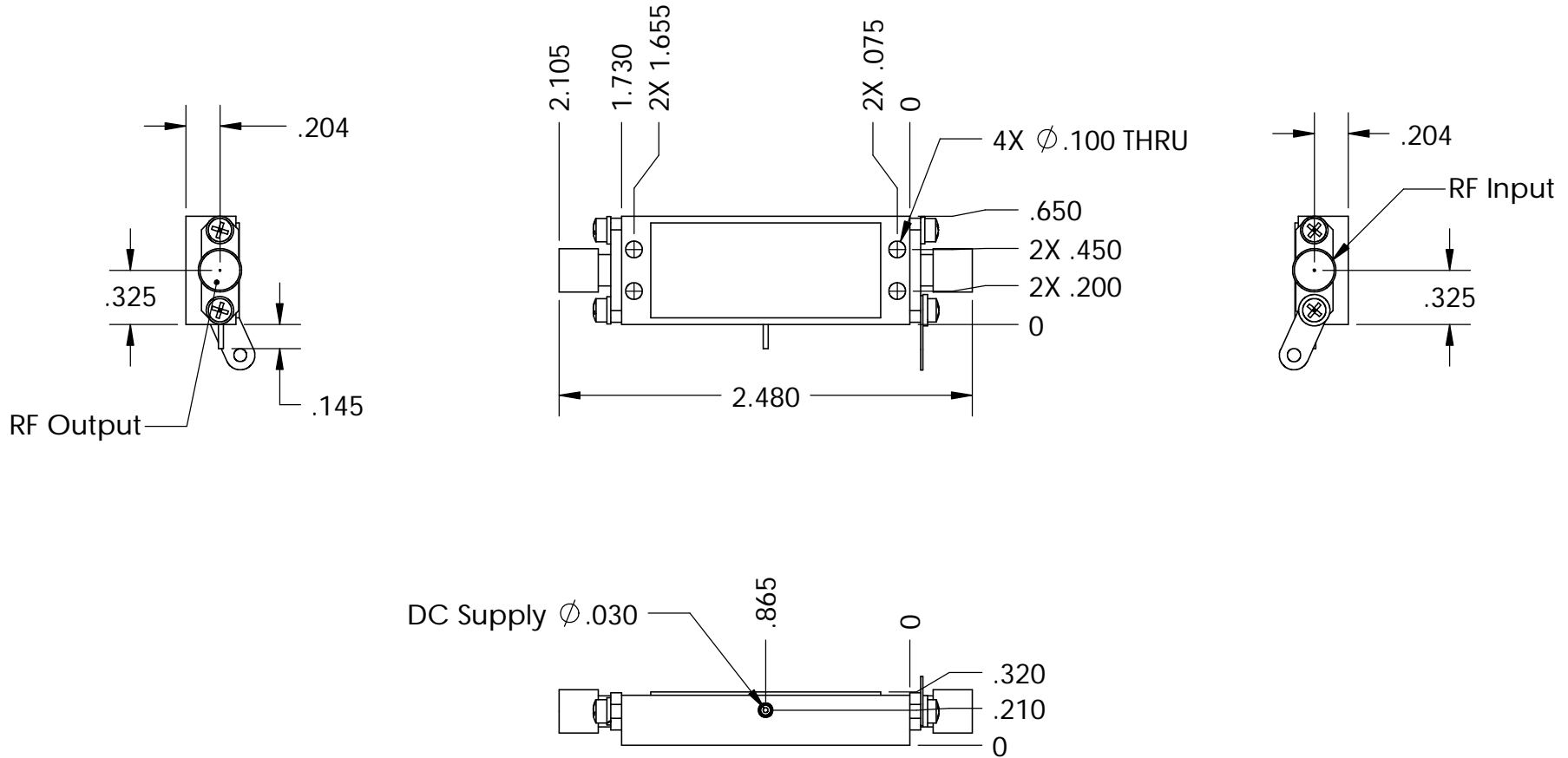

UNLESS OTHERWISE SPECIFIED DIMENSIONS ARE IN INCHES TOLERANCES ARE: FRACTIONS DECIMALS ANGLES ±.010 ±.01	CAD GENERATED DRAWING, DO NOT MANUALLY UPDATE		Lucix Corporation ALL INFORMATION CONTAINED IN THIS DRAWING IS THE SOLE PROPERTY OF THE LUCIX CORPORATION. Outline, SK5 Amplifier
	APPROVALS	DATE	
	DRAWN B.Bufford	8/11/04	
	CHECKED		
MATERIAL n/a	RESP ENG B.Bufford	8/11/04	SIZE DWG. NO. REV. A SK5 4/8/05
FINISH n/a	MFG ENG		
DO NOT SCALE DRAWING	QUAL ENG		
SCALE 1:1		CAD FILE: OL_Amp_250_5_NoCarf	SHEET 1 OF 1